

VICINITY MAP

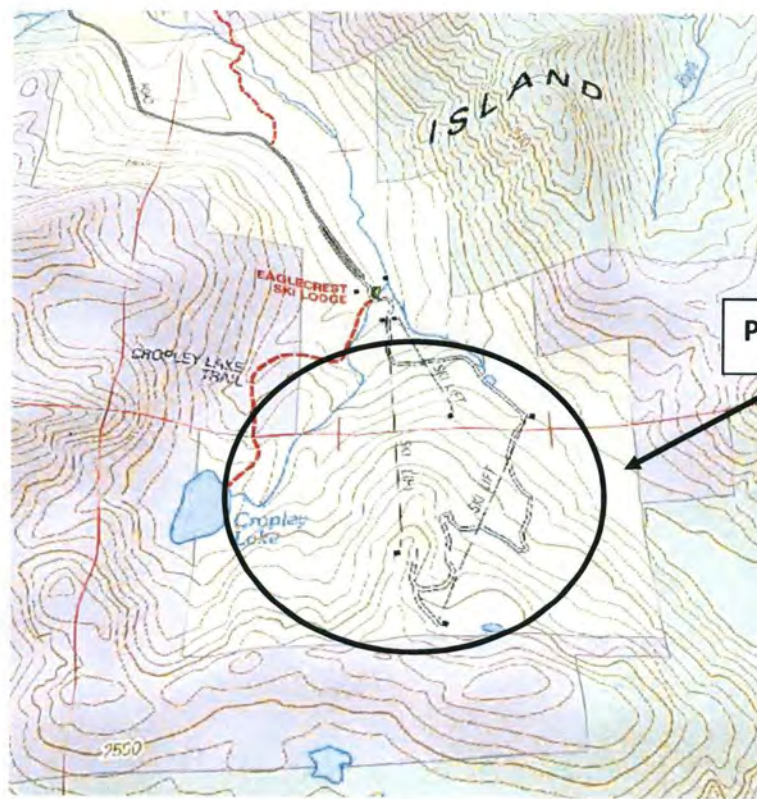
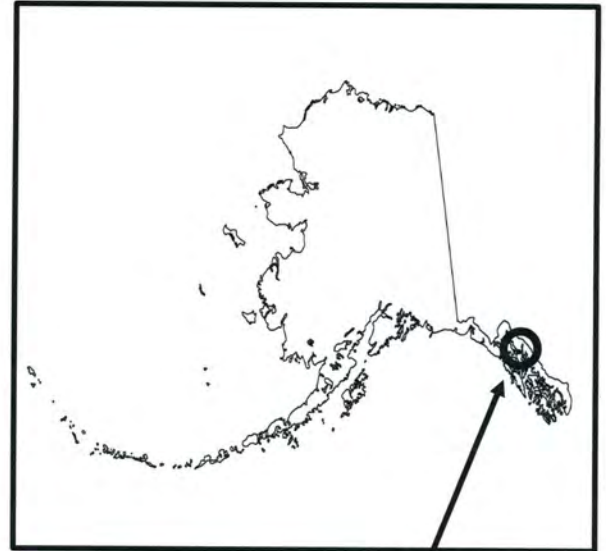

Project Area

Applicant: City & Borough of Juneau Alaska / Eaglecrest Ski Area
File No.: POA-_____
Waterway: Fish Creek drainage
Proposed activity: Road and trail construction with fill
Sec. 31 T. 41 R. 67 M: E Copper River Meridian
Lat.: N 58 ° 16 ' 27 " Long.: W 134 ° 30 ' 46 "
Sheet 1 of 20 Date: 03/02/2015

Eaglecrest Hiking, Mountain Biking and Maintenance Road Plan Overview

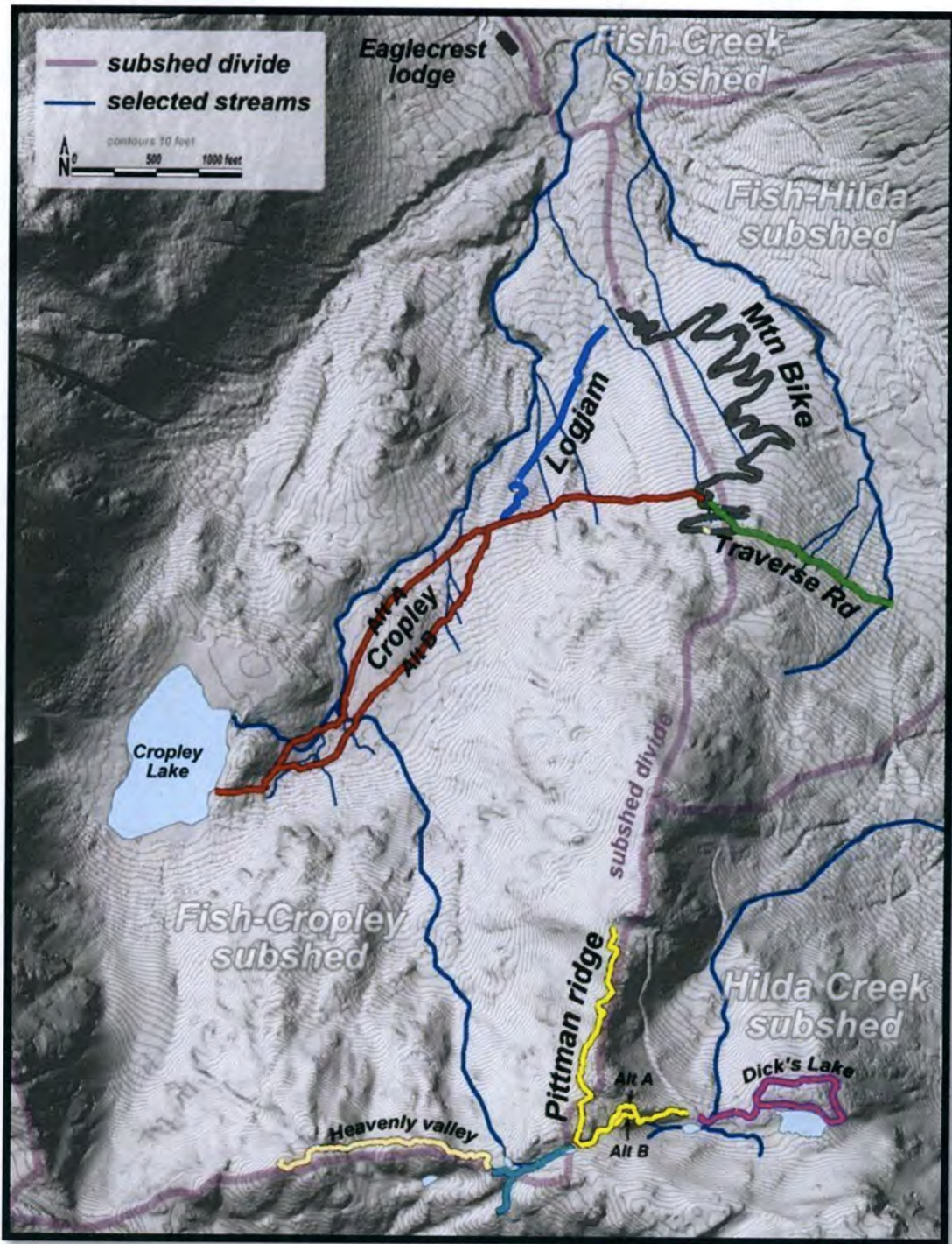

Applicant: City & Borough of Juneau Alaska / Eaglecrest Ski Area
File No.: POA-_____
Waterway: Fish Creek drainage
Proposed activity: Road and trail construction with fill
Sec. 31 T. 41 R. 67 M: E Copper River Meridian
Lat.: N 58 ° 16 ' 27 " Long.: W 134 ° 30 ' 46 "
Sheet 2 of 20 Date: 03/02/2015

Traverse Road- Summer road to top of Hooter Lift - 12 ft. wide

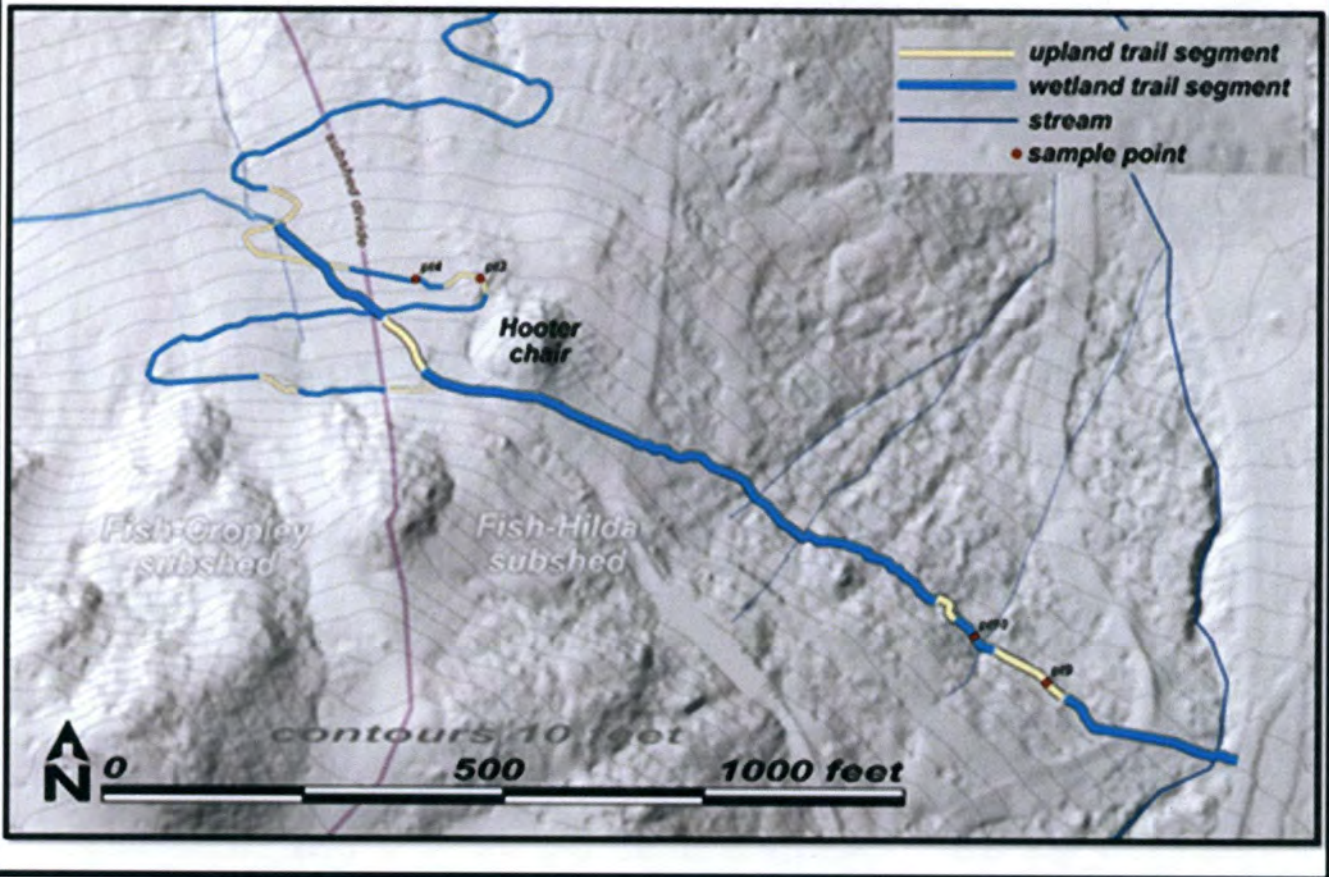

Applicant: City & Borough of Juneau Alaska / Eaglecrest Ski Area

File No.: POA-____-____

Waterway: Fish Creek drainage

Proposed activity: Road and trail construction with fill

Sec. 31 T. 41 R. 67 M: E Copper River Meridian

Lat.: N 58 ° 16 ' 27 "

Long.: W 134 ° 30 ' 46 "

Sheet 3 of 20

Date: 03/02/2015

Hooter (Summer Maintenance) Traverse Road Typical Sections

TYPICAL OVERLAY SECTION
(NTS)

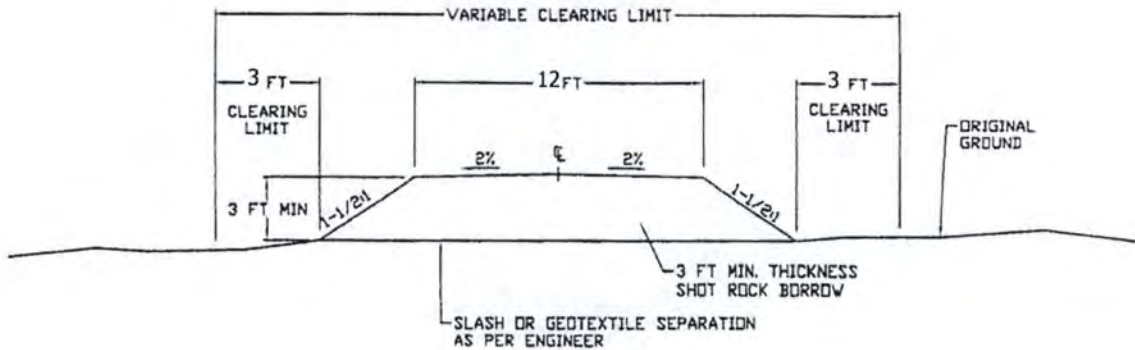

TYPICAL BALANCED CUT/FILL SECTION
(NTS)

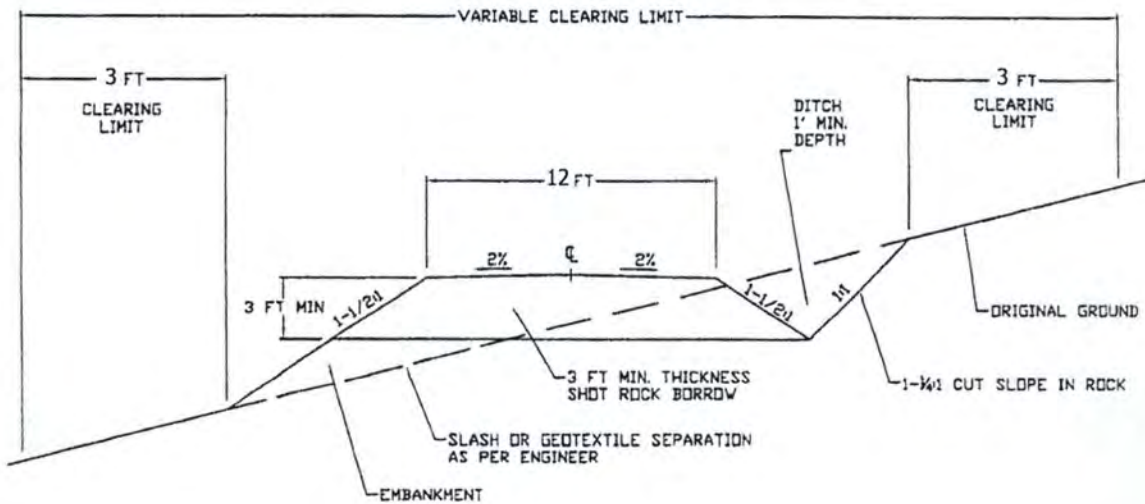

Scale as Shown

Applicant: City & Borough of Juneau Alaska / Eaglecrest Ski Area
 File No.: POA-_____
 Waterway: Fish Creek drainage
 Proposed activity: Road and trail construction with fill
 Sec. 31 T. 41 R. 67 M: E Copper River Meridian
 Lat.: N 58° 16' 27" Long.: W 134° 30' 46"
 Sheet 4 of 20 Date: 03/02/2015

Sourdough Mountain Bike Trail - 4 feet wide

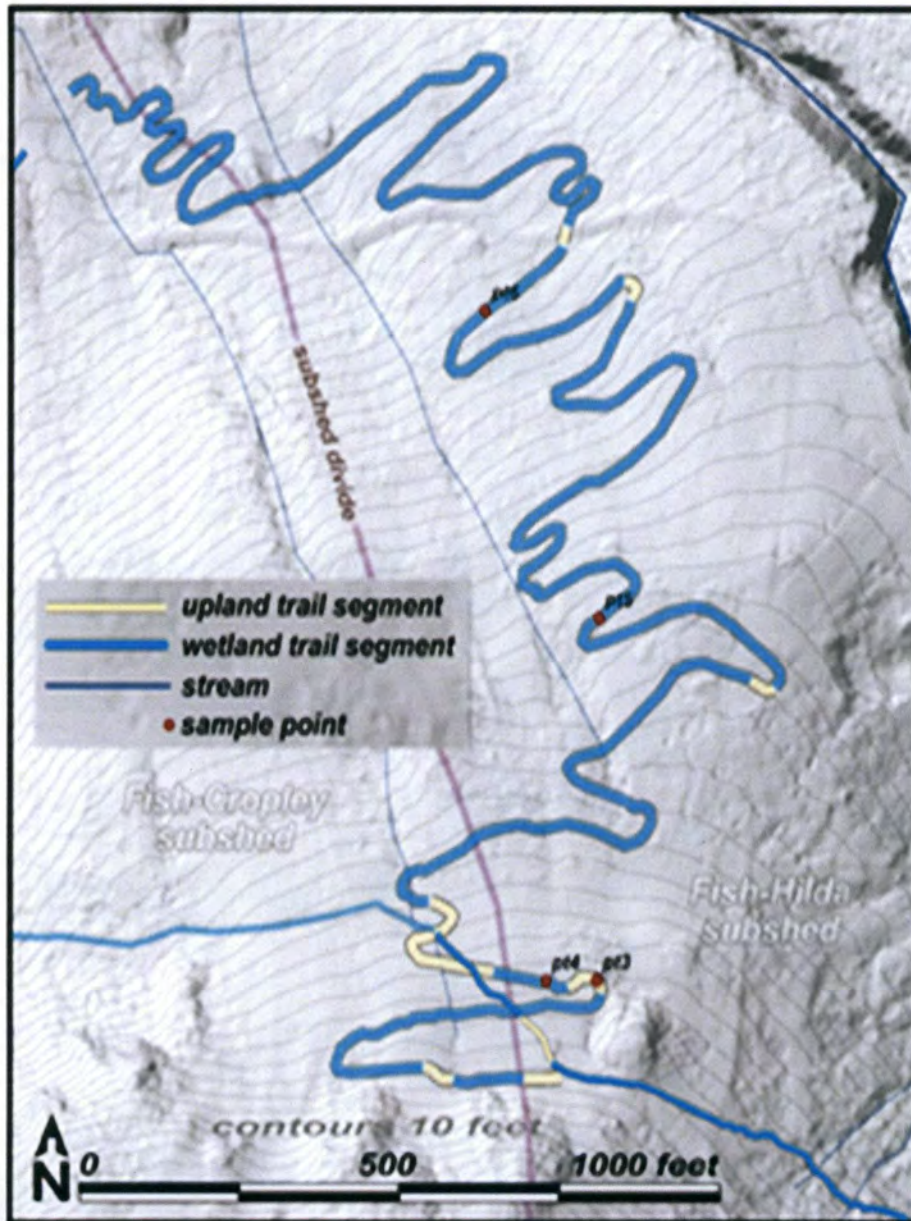

Applicant: City & Borough of Juneau Alaska / Eaglecrest Ski Area

File No.: POA-_____-_____-

Waterway: Fish Creek drainage

Proposed activity: Road and trail construction with fill

Sec. 31 T. 41 R. 67 M: E Copper River Meridian

Lat.: N 58 ° 16 ' 27 "

Long.: W 134 ° 30 ' 46 "

Sheet 5 of 20

Date: 03/02/2015

Mountain Bike Trail:
Typical Plan View

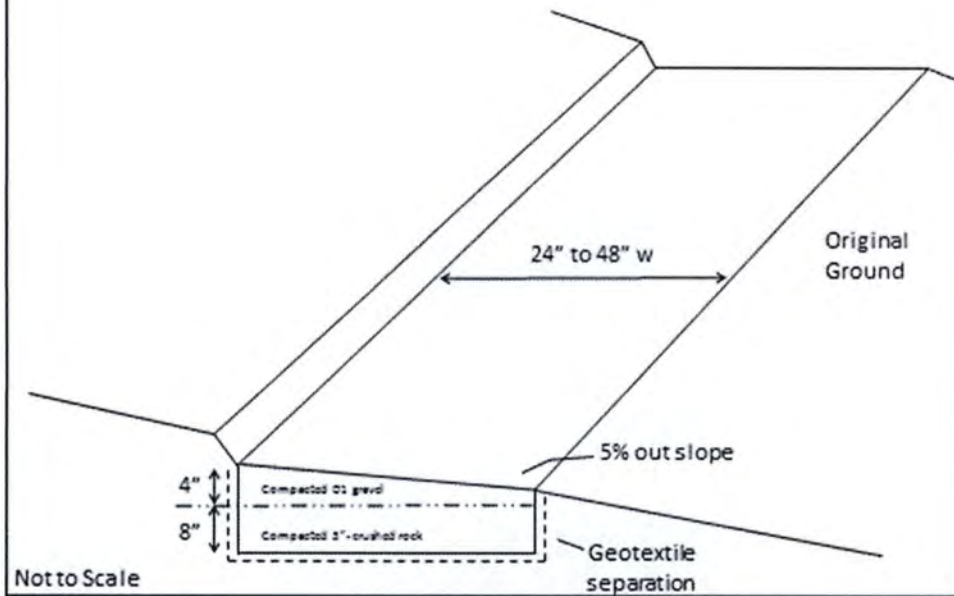

Mountain Bike Trail: Typical
Cross Section

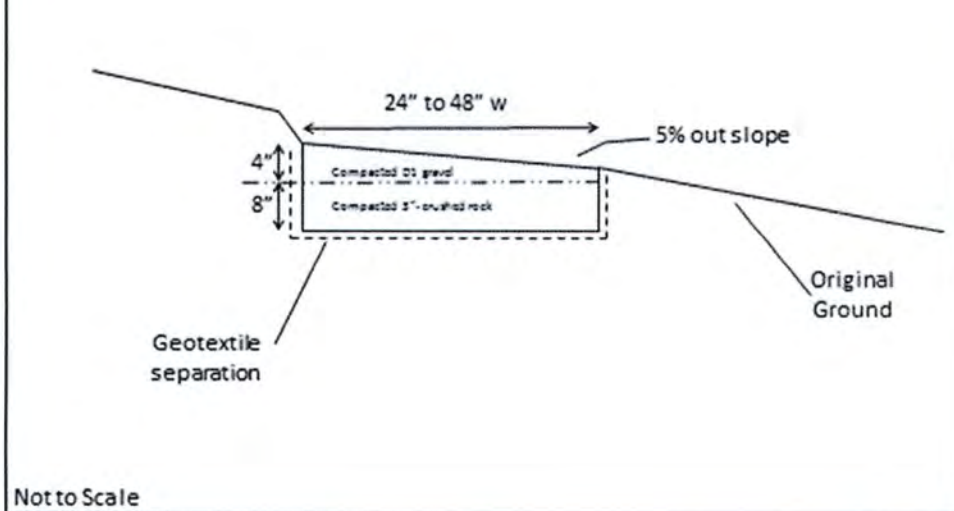

Applicant: City & Borough of Juneau Alaska / Eaglecrest Ski Area
 File No.: POA-_____
 Waterway: Fish Creek drainage
 Proposed activity: Road and trail construction with fill
 Sec. 31 T. 41 R. 67 M: E Copper River Meridian
 Lat.: N 58 ° 16 ' 27 " Long.: W 134 ° 30 ' 46 "
 Sheet 6 of 20 Date: 03/02/2015

Mountain Bike Trail: Insloped Banked Turn Typical Plan View

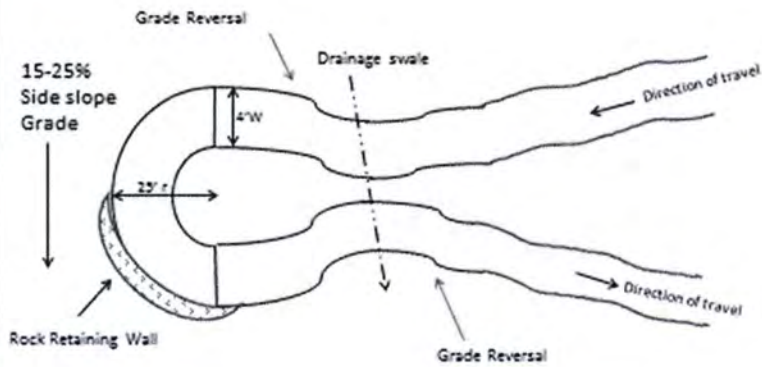

Not to Scale

Mountain Bike Trail: Insloped Banked Turn Typical Cross Section View

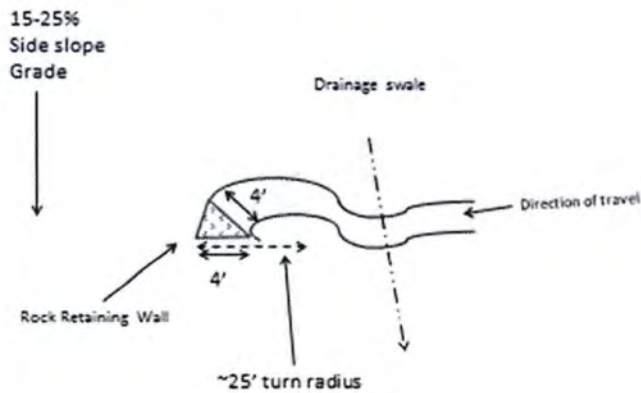

Not to Scale

Applicant: City & Borough of Juneau Alaska / Eaglecrest Ski Area
 File No.: POA-____-____
 Waterway: Fish Creek drainage
 Proposed activity: Road and trail construction with fill
 Sec. 31 T. 41 R. 67 M: E Copper River Meridian
 Lat.: N 58 ° 16 ' 27 " Long.: W 134 ° 30 ' 46 "
 Sheet 7 of 20 Date: 03/02/2015

Mountain Bike Trail: Culvert Installation
Typical Plan View

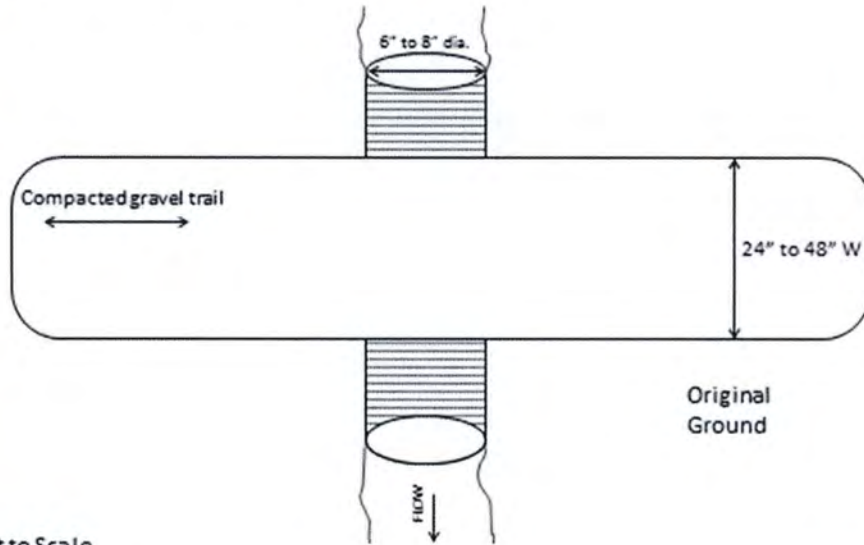

Not to Scale

Mountain Bike Trail: Culvert Installation
Typical Cross Section View

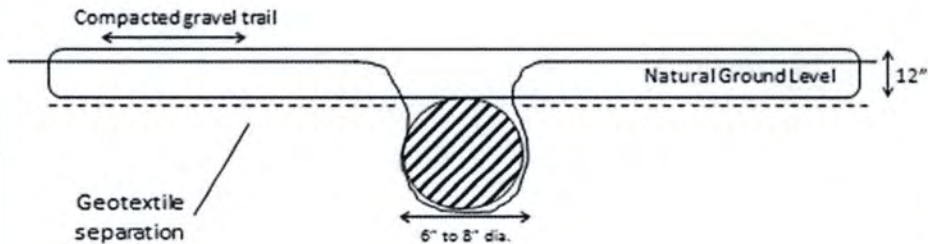

Not to Scale

Applicant: City & Borough of Juneau Alaska / Eaglecrest Ski Area

File No.: POA-____-____

Waterway: Fish Creek drainage

Proposed activity: Road and trail construction with fill

Sec. 31 T. 41 R. 67 M: E Copper River Meridian

Lat.: N 58 ° 16 ' 27 "

Long.: W 134 ° 30 ' 46 "

Sheet 8 of 20

Date: 03/02/2015

Mountain Bike Trail: Wood Plank Drainage Crossing Typical Plan View

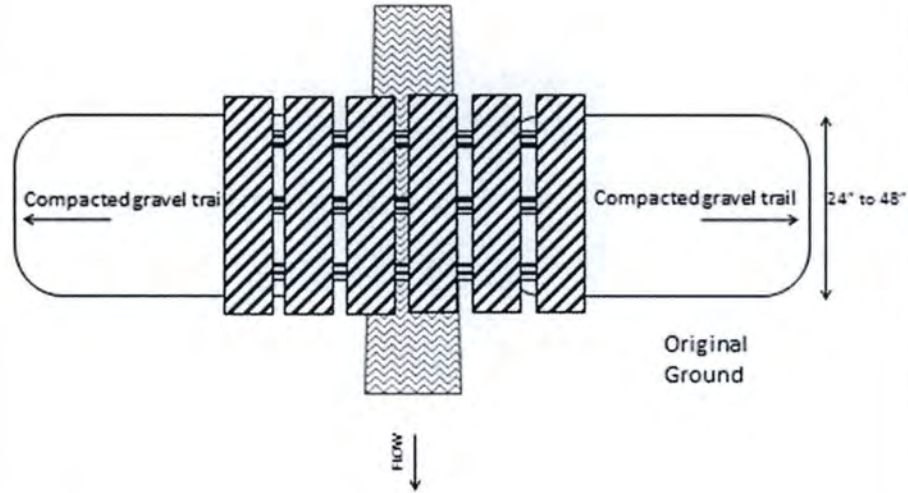

Not to Scale

Mountain Bike Trail: Wood Plank Drainage Crossing Typical Cross Section View

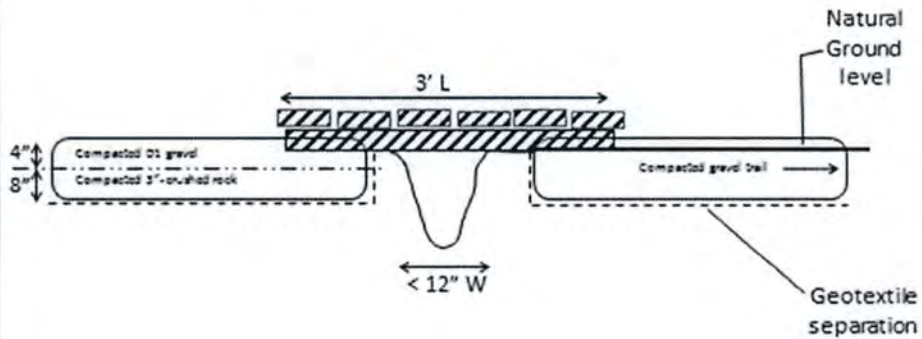

Not to Scale

Applicant: City & Borough of Juneau Alaska / Eaglecrest Ski Area
 File No.: POA-____-____
 Waterway: Fish Creek drainage
 Proposed activity: Road and trail construction with fill
 Sec. 31 T. 41 R. 67 M: E Copper River Meridian
 Lat.: N 58 ° 16 ' 27 '' Long.: W 134 ° 30 ' 46 ''
 Sheet 9 of 20 Date: 03/02/2015

Pittman's Ridge Trail Loop-
w/ alternatives A&B - 24" wide
Preferred route is Alternate A



Logjam Trail- 24" wide



Dicks Lake Trail - 18" wide

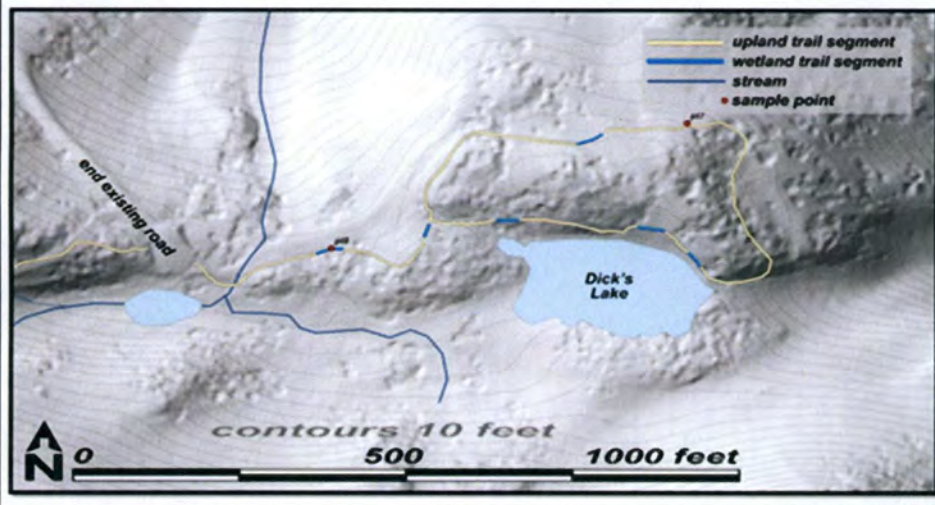

Applicant: City & Borough of Juneau Alaska / Eaglecrest Ski Area
 File No.: POA-_____
 Waterway: Fish Creek drainage
 Proposed activity: Road and trail construction with fill
 Sec. 31 T. 41 R. 67 M: E Copper River Meridian
 Lat.: N 58 ° 16 ' 27 " Long.: W 134 ° 30 ' 46 "
 Sheet 10 of 20 Date: 03/02/2015

Stephens Passage Overlook Trail - 24" wide

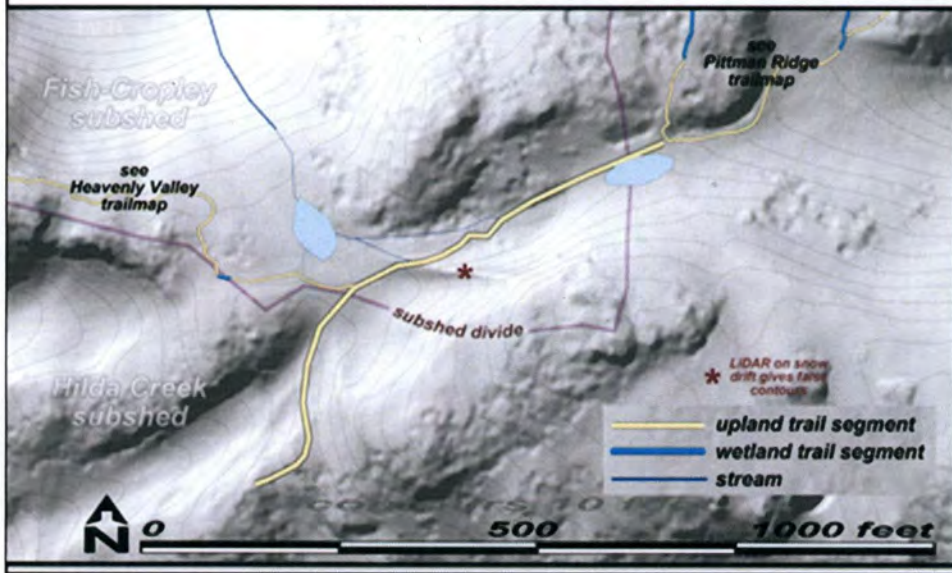

Heavenly Valley Overlook Trail - 18" wide

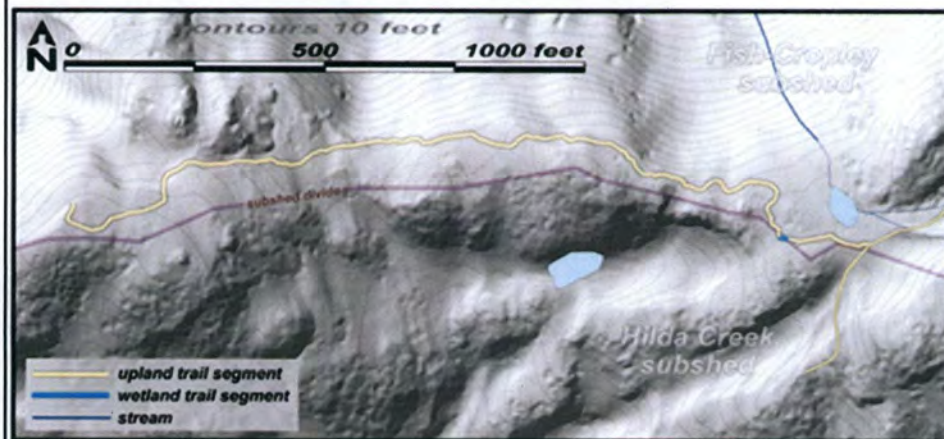

Applicant: City & Borough of Juneau Alaska / Eaglecrest Ski Area

File No.: POA-____-____

Waterway: Fish Creek drainage

Proposed activity: Road and trail construction with fill

Sec. 31 T. 41 R. 67 M: E Copper River Meridian

Lat.: N 58° 16' 27" Long.: W 134° 30' 46"

Sheet 11 of 20

Date: 03/02/2015

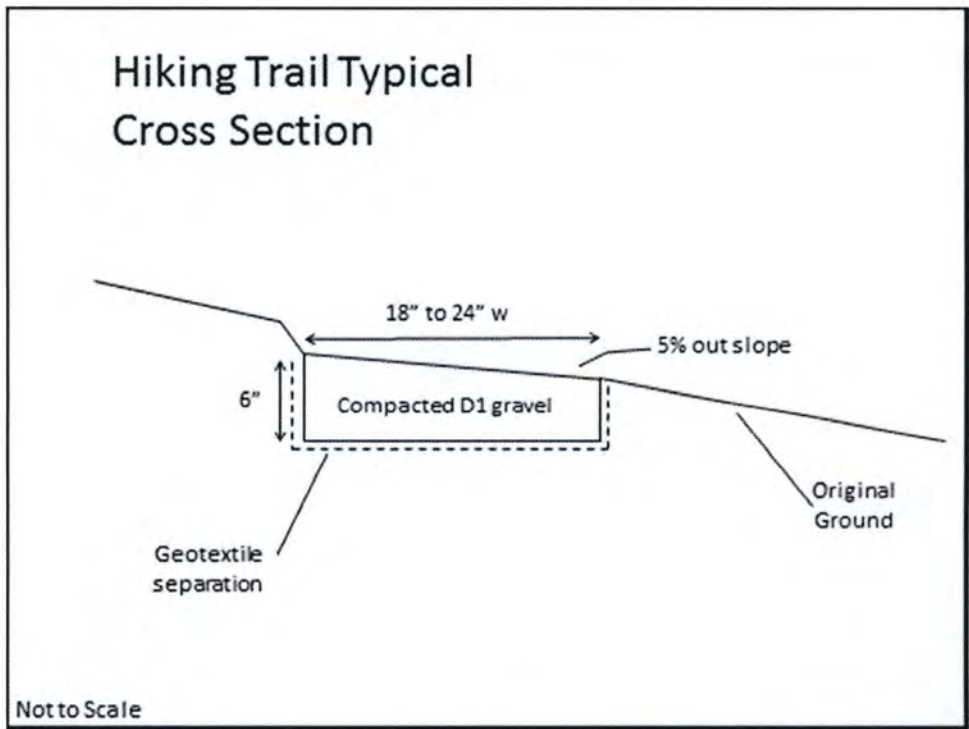
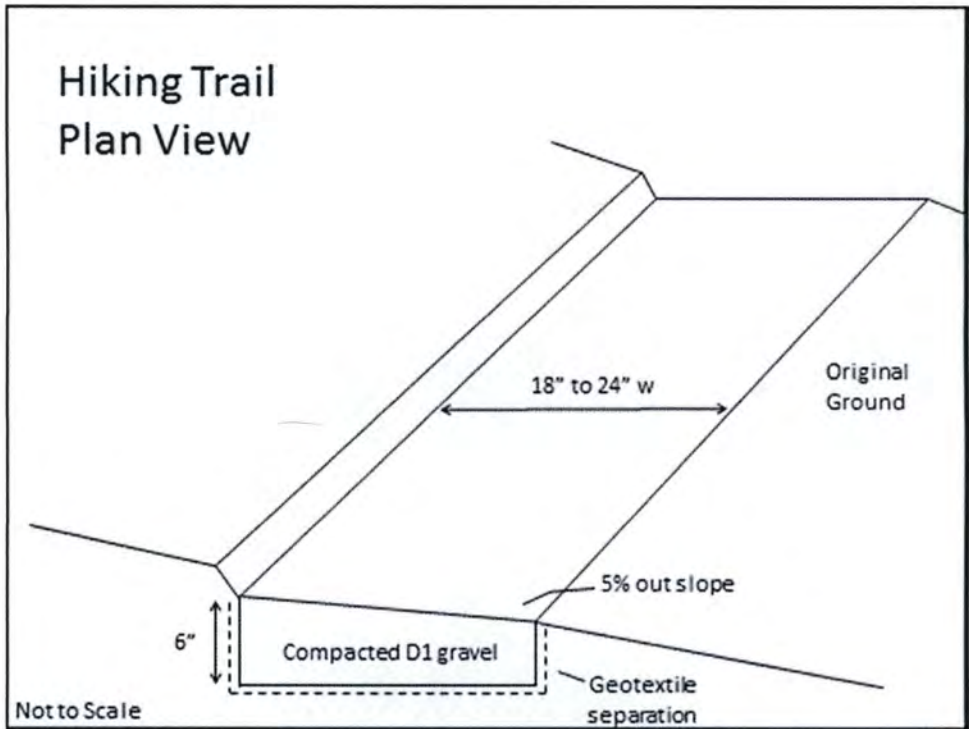

Applicant: City & Borough of Juneau Alaska / Eaglecrest Ski Area
 File No.: POA-____-____
 Waterway: Fish Creek drainage
 Proposed activity: Road and trail construction with fill
 Sec. 31 T. 41 R. 67 M: E Copper River Meridian
 Lat.: N 58 ° 16 ' 27 " Long.: W 134 ° 30 ' 46 "
 Sheet 12 of 20 Date: 03/02/2015

Hiking Trail Culvert Typical Installation Plan View

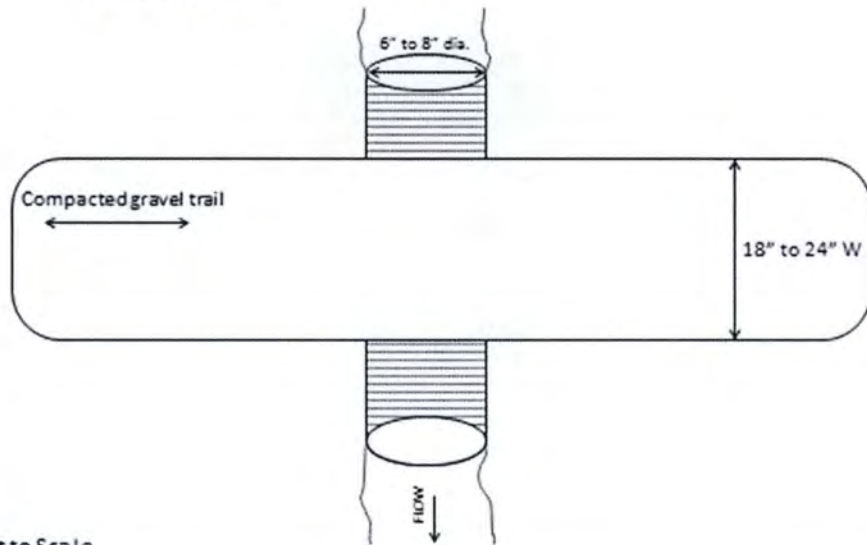

Not to Scale

Hiking Trail: Culvert Typical Installation Typical Cross Section View

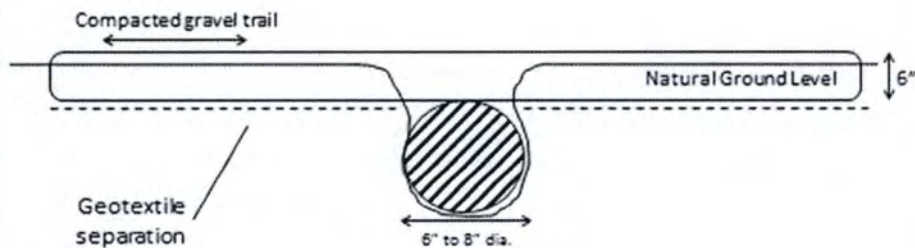

Not to Scale

Applicant: City & Borough of Juneau Alaska / Eaglecrest Ski Area
 File No.: POA-____-____
 Waterway: Fish Creek drainage
 Proposed activity: Road and trail construction with fill
 Sec. 31 T. 41 R. 67 M: E Copper River Meridian
 Lat.: N 58 ° 16 ' 27 " Long.: W 134 ° 30 ' 46 "
 Sheet 13 of 20 Date: 03/02/2015

Wood Plank Drainage Crossing on Hiking Trail Plan View

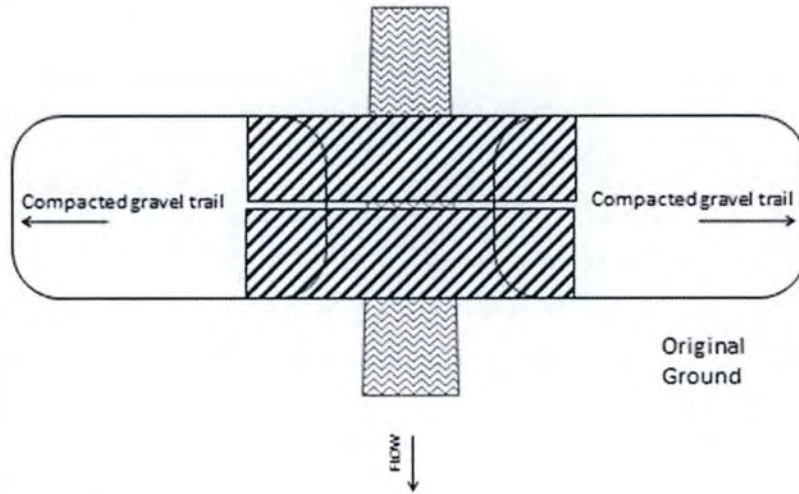

Not to Scale

Wood Plank Drainage Crossing on Hiking Trail Typical Cross Section View

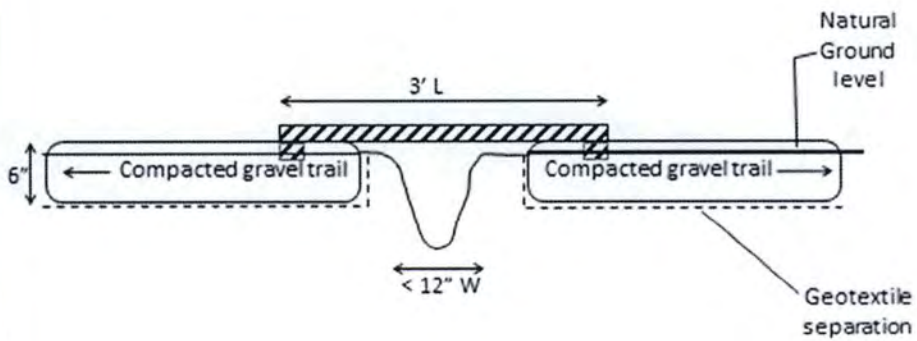

Not to Scale

Applicant: City & Borough of Juneau Alaska / Eaglecrest Ski Area
 File No.: POA-____-____
 Waterway: Fish Creek drainage
 Proposed activity: Road and trail construction with fill
 Sec. 31 T. 41 R. 67 M: E Copper River Meridian
 Lat.: N 58 ° 16 ' 27 " Long.: W 134 ° 30 ' 46 "
 Sheet 14 of 20 Date: 03/02/2015

Hiking Trail With Raised Turnpike Plan View

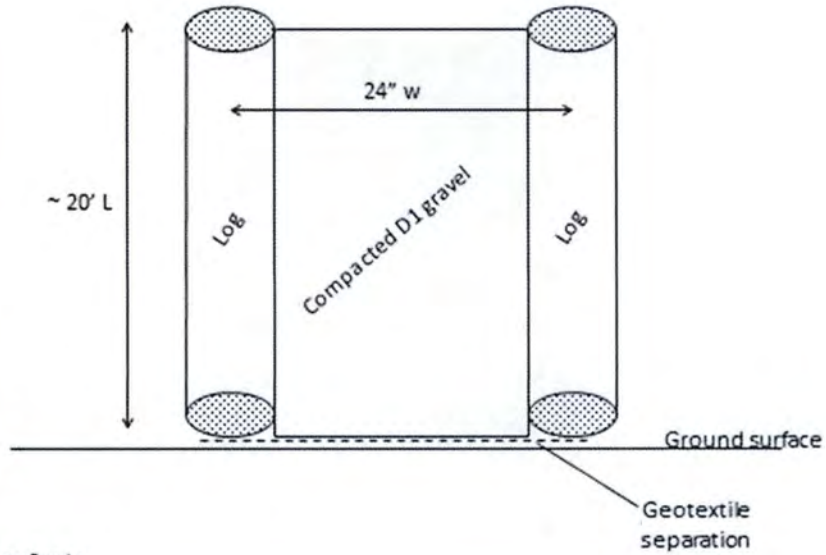

Hiking Trail With Raised Turnpike Plan View

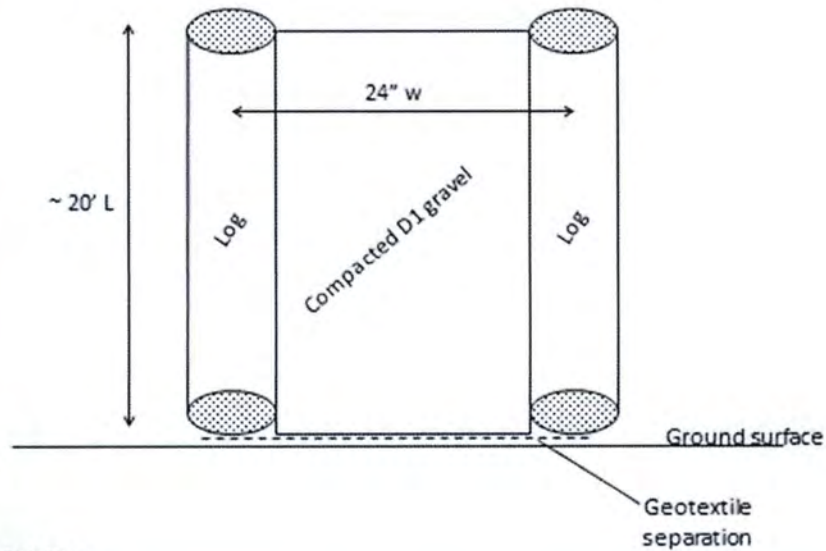

Applicant: City & Borough of Juneau Alaska / Eaglecrest Ski Area
File No.: POA-____-____
Waterway: Fish Creek drainage
Proposed activity: Road and trail construction with fill
Sec. 31 T. 41 R. 67 M: E Copper River Meridian
Lat.: N 58 ° 16 ' 27 '' Long.: W 134 ° 30 ' 46 ''
Sheet 15 of 20 Date: 03/02/2015

Traverse Trail Hooter to Cropley Lake - w/ alternatives A & B - 5 feet wide

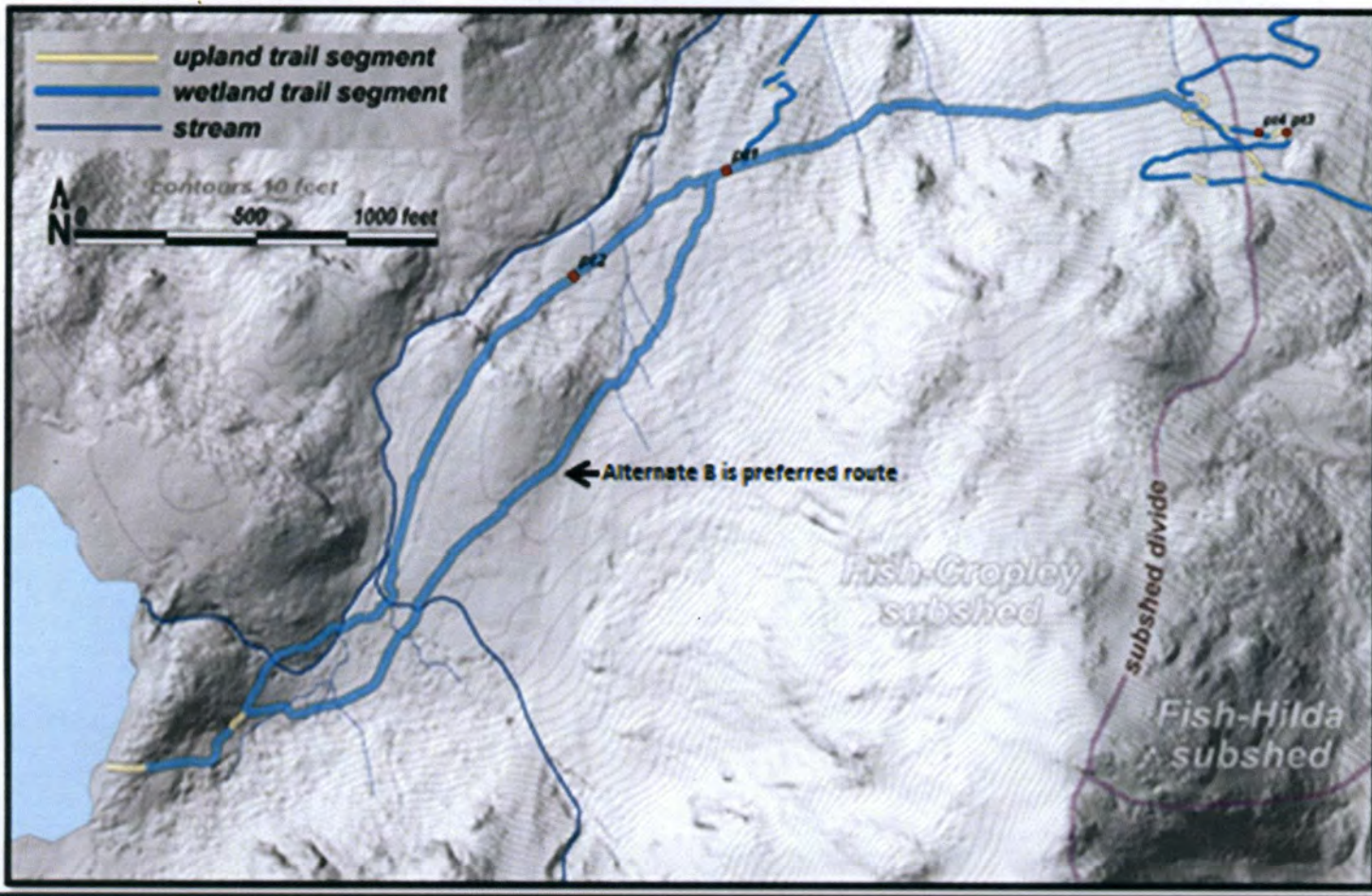

Applicant: City & Borough of Juneau Alaska / Eaglecrest Ski Area
File No.: POA-____-____
Waterway: Fish Creek drainage
Proposed activity: Road and trail construction with fill
Sec. 31 T. 41 R. 67 M: E Copper River Meridian
Lat.: N 58° 16' 27" Long.: W 134° 30' 46"
Sheet 16 of 20 Date: 03/02/2015

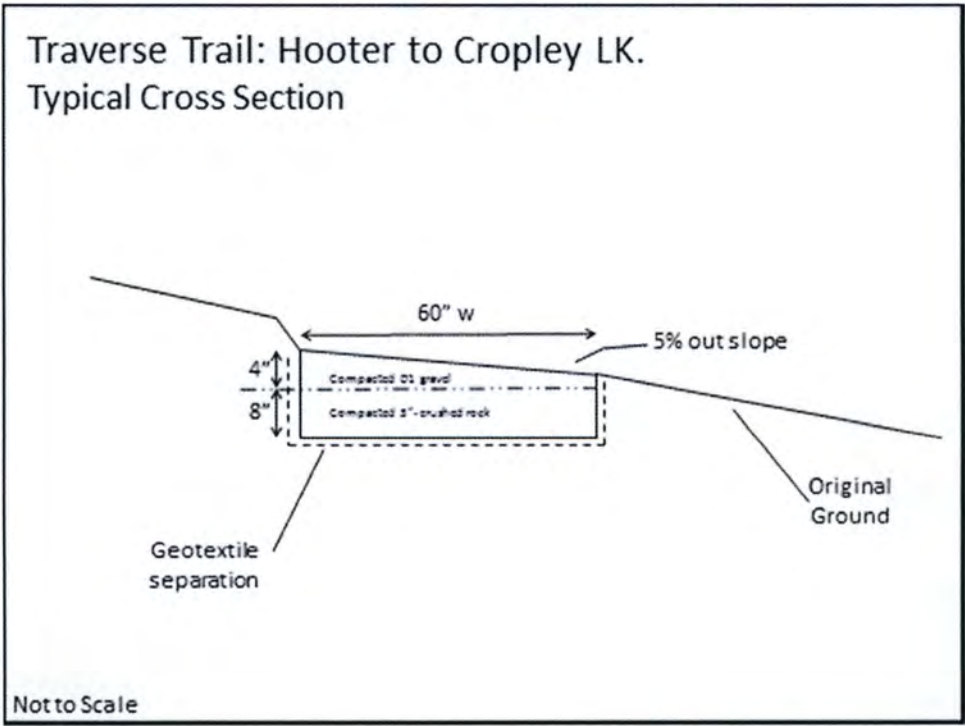
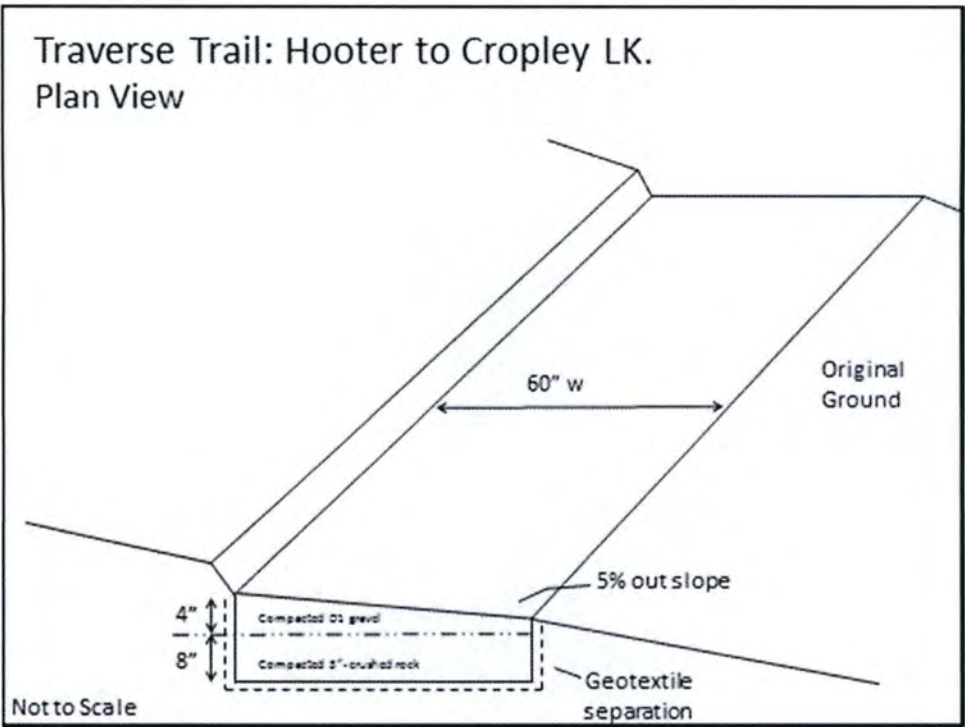

Applicant: City & Borough of Juneau Alaska / Eaglecrest Ski Area
 File No.: POA-____-____
 Waterway: Fish Creek drainage
 Proposed activity: Road and trail construction with fill
 Sec. 31 T. 41 R. 67 M: E Copper River Meridian
 Lat.: N 58° 16' 27" Long.: W 134° 30' 46"
 Sheet 17 of 20 Date: 03/02/2015

Traverse Trail: Culvert Installation
Typical Plan View

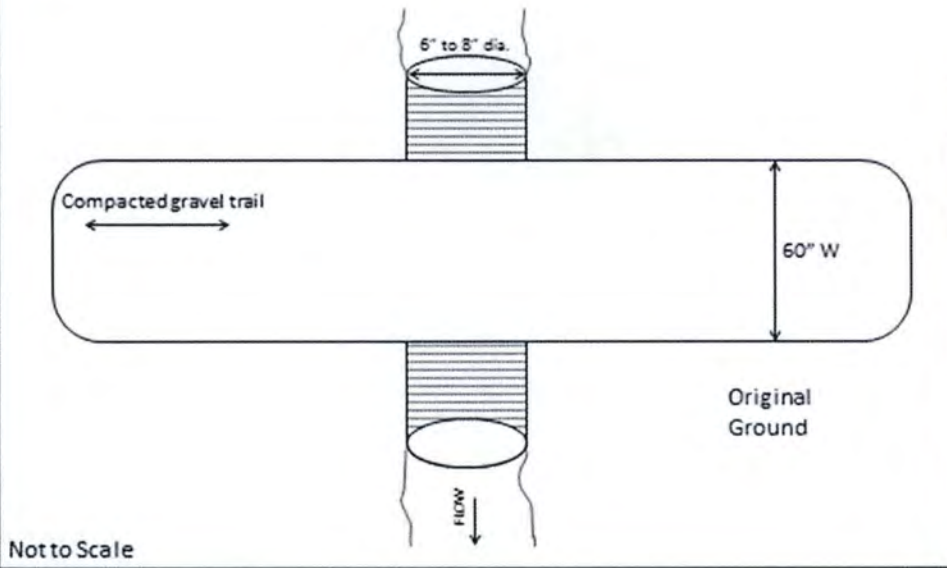

Traverse Trail: Culvert Installation
Typical Cross Section View

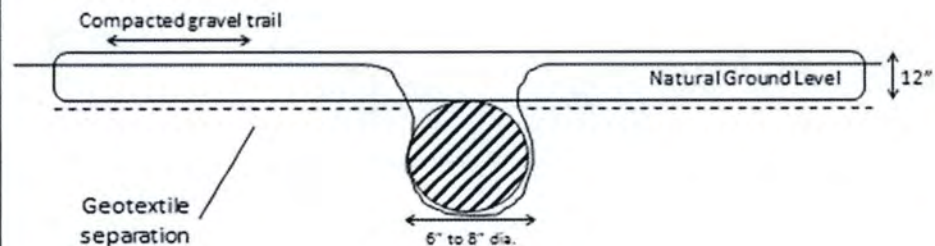

Applicant: City & Borough of Juneau Alaska / Eaglecrest Ski Area
 File No.: POA-____-____
 Waterway: Fish Creek drainage
 Proposed activity: Road and trail construction with fill
 Sec. 31 T. 41 R. 67 M: E Copper River Meridian
 Lat.: N 58 ° 16 ' 27 " Long.: W 134 ° 30 ' 46 "
 Sheet 18 of 20 Date: 03/02/2015

Traverse Trail: Wood Bridge Creek Crossing
Typical Plan View

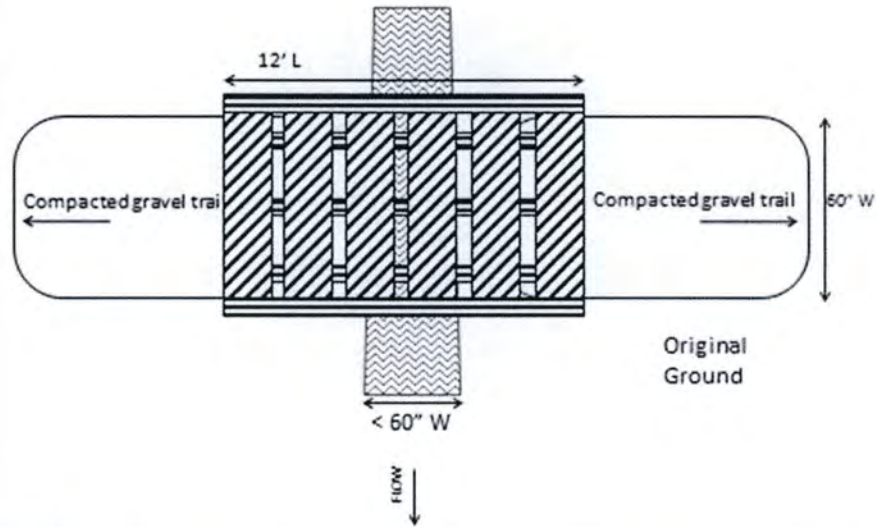

Not to Scale

Traverse Trail: Wood Bridge Creek Crossing
Typical Cross Section View

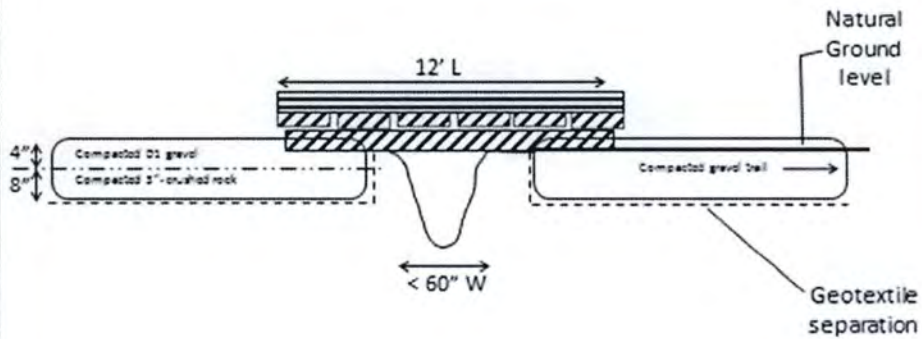

Not to Scale

Applicant: City & Borough of Juneau Alaska / Eaglecrest Ski Area
 File No.: POA-____-____
 Waterway: Fish Creek drainage
 Proposed activity: Road and trail construction with fill
 Sec. 31 T. 41 R. 67 M: E Copper River Meridian
 Lat.: N 58 ° 16 ' 27 " Long.: W 134 ° 30 ' 46 "
 Sheet 19 of 20 Date: 03/02/2015

Wetland Effected Trail Lengths, Area and Fill Table

WETLAND EFFECTED TRAIL LENGTHS ONLY				Gravel Fill		
Trail Name	Area sqft.	Width in ft.	Length in ft.	Fill Depth	3"- / D1 cu yd	Shotrock cu yd.
Traverse - Hooter Summer road	14388	12	1199	36"		1598.67
Pittmans Alt A	1211	2	605.5	6"	22.43	
Log Jam	3068	2	1534	6"	56.81	
Sourdough MTB	26180	4	6545	12"	969.63	
Stephens Passage overlook	0		0	6"	0.00	
Traverse trail Alt B	19750	5	3950	12"	731.48	
Dicks Lake	345	1.5	230	6"	6.39	
Heavenly Valley Overlook	25.5	1.5	17	6"	0.47	
sub totals			14080.5		1787.21	1598.67
Total wetland square footage	64967.5					
(Acres)	1.49					
			Total wetland effected trail length	14080.5		
				Total cubic yards of fill on wetlands		3385.88

Applicant: City & Borough of Juneau Alaska / Eaglecrest Ski Area
 File No.: POA-____-____
 Waterway: Fish Creek drainage
 Proposed activity: Road and trail construction with fill
 Sec. 31 T. 41 R. 67 M: E Copper River Meridian
 Lat.: N 58 ° 16 ' 27 " Long.: W 134 ° 30 ' 46 "
 Sheet 20 of 20 Date: 03/02/2015

Hooter (Summer Maintenance) Traverse Road Culvert installations Typical

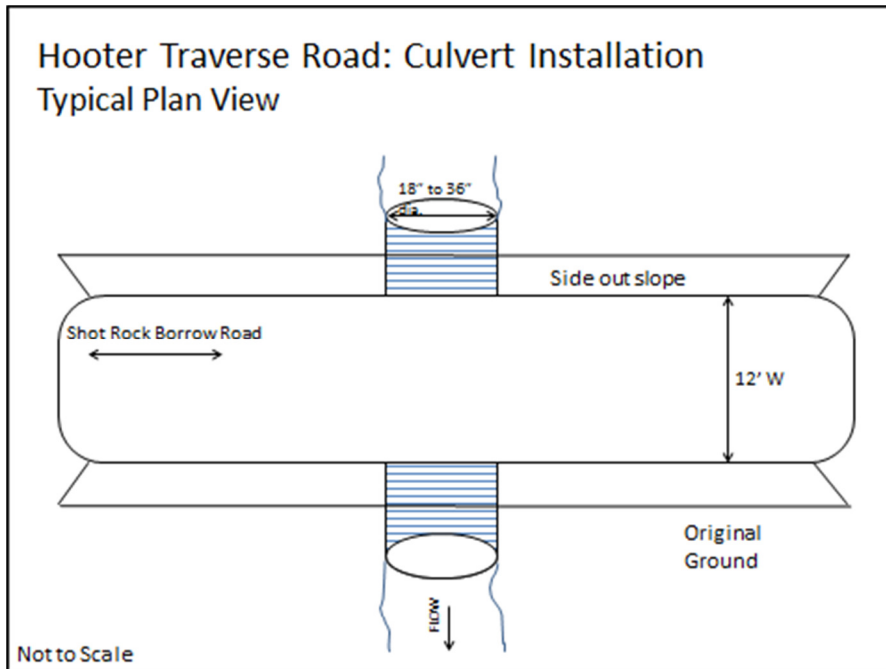
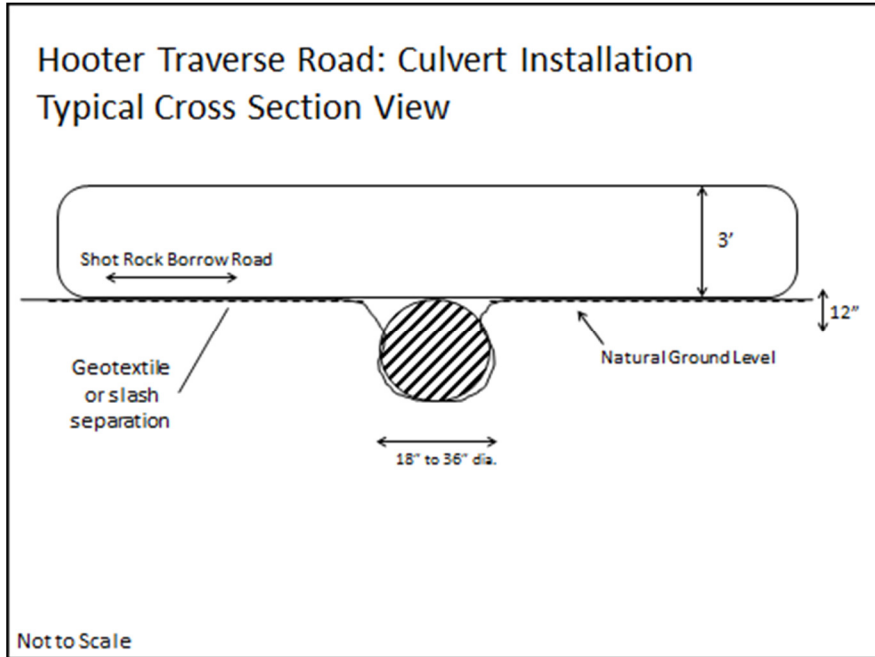

Applicant: City & Borough of Juneau Alaska / Eaglecrest Ski Area
 File No.: POA-____-____
 Waterway: Fish Creek drainage
 Proposed activity: Road and trail construction with fill
 Sec. 31 T. 41 R. 67 M:E Copper River Meridian
 Lat.: N 58 ° 16 ' 27 " Long.: W 134 ° 30 ' 46 "
 Sheet 21 of 21 Date: 04/22/2015